



LED NEON FLEX SPECIFICATION

IP67 NEON D16 24V TOP VIEW



Note: LEDYI may change product specifications and installation guidance without prior notice.

- Using Dow Chemical brand silicone rubber
- Eco-friendly silicone with integrated extrusion process
- Unique optical design for even, shadow-free illumination
- IP67 with resistance to salts, acids, alkalis, and UV
- Matt finished surface, dust-resistant

2100K
2400K
2700K
3000K
3500K
4000K
5000K
6000K

2100k
~
6000k



Dimensions & Waterproof

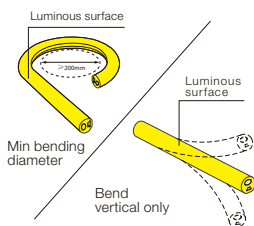
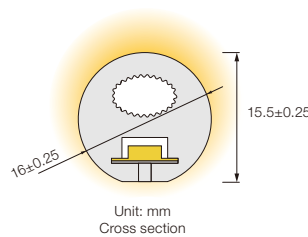
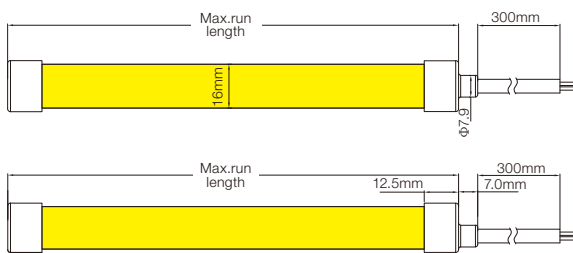

Electrical Parameter

Voltage	DC24V
LED PIN Temperature	Max. 65°C
Storage Temperature	-25°C~ 60°C
Ambient Temperature	Min.-25°C, Max (Table below)
CRI	>90

Specification

Power	5 w/m	10 w/m
Efficacy@4000K	73lm/w	70.7lm/w
Max Ambient Temperature	55°C	45°C

Due to the tolerance of the production and electrical components, output value and electrical power can vary up to 10%

Length Standard

Length Range (M)	Final Length	Tolerance
0M<Neon Strip(L)° 5M	L+8	±7
5M<Neon Strip(L)° 10M	L+8	±10
10M<Neon Strip(L)° 15M	L+8	±13

Length Range (M)	Final Length	Tolerance
15M<Neon Strip(L)° 20M	L+8	±16
20M<Neon Strip(L)° 25M	L+8	±19

Single color (Lm/m)

CCT(K)	CRI	Voltage	Power(W)	Lumen (LM/M)	Efficiency (LM/W)	Unit Length (mm)	Max. Run Length (M)	CC/CV
2100K±100	90	DC24V	10	560	56	50	13 (CC)	CC/CV
2400K±100	90	DC24V	10	590	59	50	13 (CC)	CC/CV
2700K±100	90	DC24V	10	660	66	50	13 (CC)	CC/CV
3000K±100	90	DC24V	10	650	65	50	13 (CC)	CC/CV
3500K	90	DC24V	10	630	63	50	13 (CC)	CC/CV
4000K	90	DC24V	10	700	70	50	13 (CC)	CC/CV
5000K	90	DC24V	10	730	73	50	13 (CC)	CC/CV
6000K	90	DC24V	10	730	73	50	13 (CC)	CC/CV
Red	--	DC24V	10	310	31	50	17 (CC)	CC/CV
Green	--	DC24V	10	780	78	50	13 (CC)	CC/CV
Blue	--	DC24V	10	160	16	50	13 (CC)	CC/CV
Yellow	--	DC24V	10	240	24	50	17 (CC)	CC/CV
Pink	--	DC24V	10	330	33	50	13 (CC)	CC/CV

CCT Tunable (Lm/m)





CCT(K)	CRI	Voltage	Power(W)	Lumen (LM/M)	Efficiency (LM/W)	Unit Length (mm)	Max. Run Length (M)	CC/CV
WW	90	DC24V	5	365	73	50	5	CV
W	90	DC24V	5	375	75	50	5	CV
W+WW	90	DC24V	10	730	73	50	5	CV

RGB (Lm/m)

CCT(K)	CRI	Voltage	Power(W)	Lumen (LM/M)	Efficiency (LM/W)	Unit Length (mm)	Max. Run Length (M)	CC/CV
R	--	DC24V	3.3	75.9	23	50	5	CV
G	--	DC24V	3.3	231	70	50	5	CV
B	--	DC24V	3.3	46.2	14	50	5	CV
RGB	--	DC24V	10	350	35	50	5	CV

- The maximum series length refers to the maximum single end power supply length of the constant current strip under the condition of standard 30cm wire .
- The given color temperature is the temperature of finished product.
- The given data are typical values due to the tolerances of the production process and the electrical components, values for light output and electrical power can vary up to 10%.
- All products can be dimmed; the dimmer' s voltage should conform to the rated voltage of the led light.
- The Constant Current version supports PWM dimming, but the PWM frequency must be kept below **2kHz**.

Cable

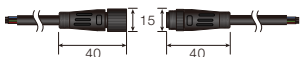
Cable Type	Schematic Diagram	Specification	Core	Electrical Properties
PVC Cable		OD: 5.0mm / Inner core: 20AWG	●●	Red V+, Black V-
		OD: 5.0mm / Inner core: 20AWG	●○●	Brown V+, White W, Yellow WW
		OD: 5.5mm / Inner core: 20AWG	●●●●	Black V+, Blue B, Green G, Red R
Waterproof Connector with PVC Cable		OD: 5.0mm / Inner core: 20AWG M12Male / Female connecto	●●	Red V+, Black V-
		OD: 5.0mm / Inner core: 20AWG M12Male / Female connecto	●○●	Brown V+, White W, Yellow WW
		OD: 5.5mm / Inner core: 20AWG M12Male / Female connecto	●●●●	Black V+, Blue B, Green G, Red R

Cable outlet

Silicone end cap

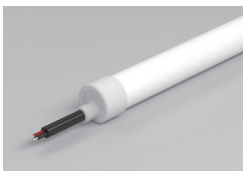

Front Cable Entry

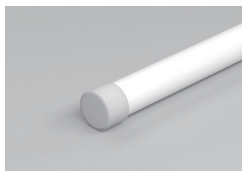

Closed End cap

Cutting Mark

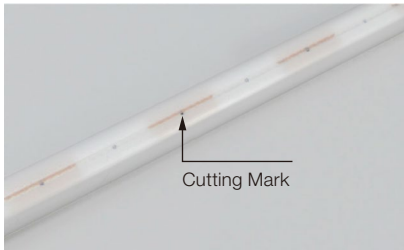

Remark:
The bottom of the led strip has transparent window, the black marker is the cutting position



Use professional scissors to cut vertically at the cutting mark

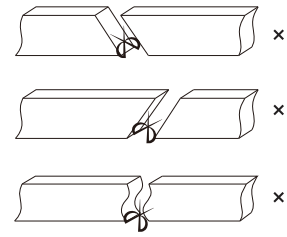

Please don't be feel free to cut and cut into an oblique angle or cambered section.

Mounting Accessories



PC Profile
20x16.6x15.3mm(L x W x H)
Accessories:Screw M3x15mm

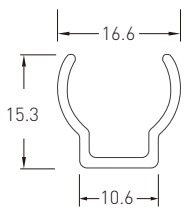

PC Profile
1000(±5)x16.6x15.3mm(L x W x H)
Accessories:Screw M3x15mm

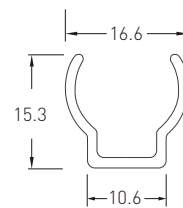

Single Color Connection Diagram

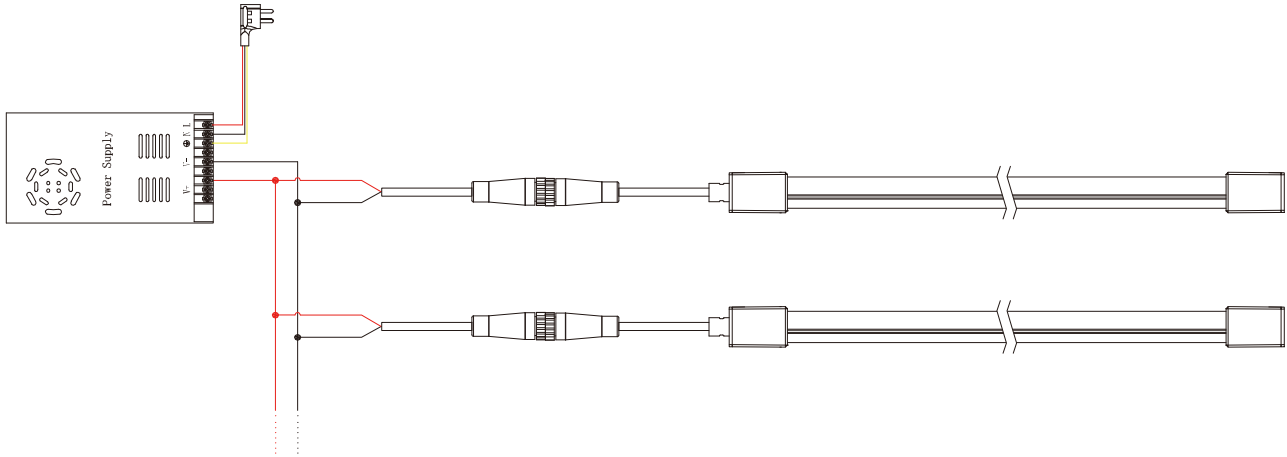

Tunable white Connection Diagram

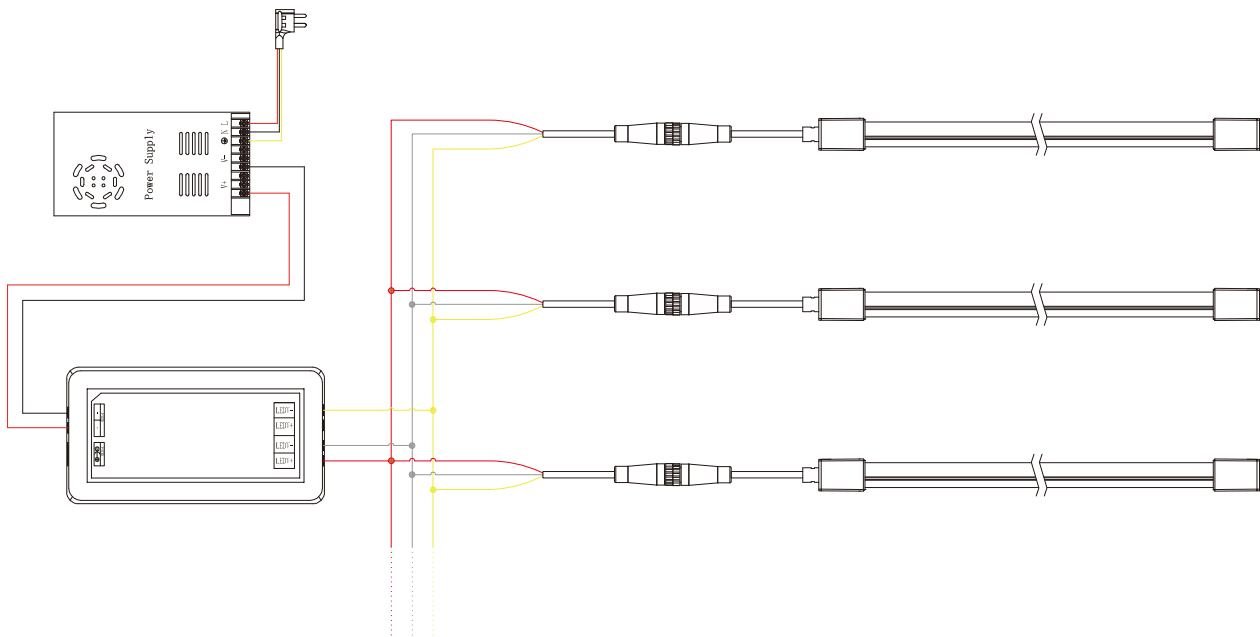

RGB Connection Diagram

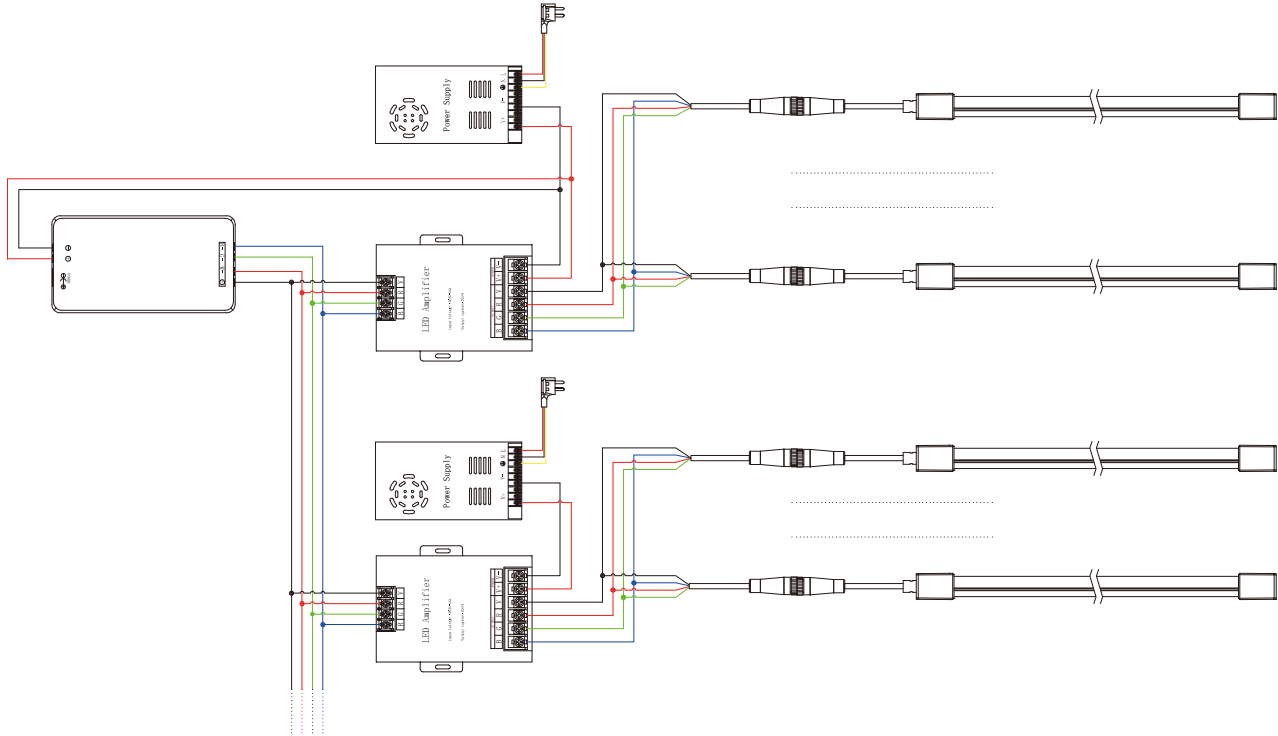

Notes

The selection of the cable specification at the output end of the power supply, it depends on the total current of the load and the length of the cable. It is recommended to select according to the following table:

Current of the light	Specifications of the cable								
	L=1M	L=2M	L=4M	L=6M	L=8M	L=10M	L=12M	L=14M	L=16M
1A	AWG26	AWG23	AWG21	AWG18	AWG18	AWG17	AWG16	AWG15	AWG15
2A	AWG23	AWG21	AWG18	AWG16	AWG15	AWG14	AWG13	AWG12	AWG12
3A	AWG22	AWG18	AWG16	AWG14	AWG13	AWG12	AWG11	AWG11	AWG10
4A	AWG21	AWG18	AWG15	AWG13	AWG12	AWG11	AWG10	AWG9	AWG9
5A	AWG20	AWG17	AWG14	AWG12	AWG11	AWG10	AWG9	AWG9	AWG8
6A	AWG18	AWG16	AWG13	AWG11	AWG10	AWG9	AWG8	AWG8	AWG7
7A	AWG18	AWG15	AWG12	AWG11	AWG9	AWG8	AWG8	AWG7	AWG6
8A	AWG17	AWG15	AWG12	AWG10	AWG9	AWG8	AWG7	AWG7	AWG6
9A	AWG17	AWG14	AWG11	AWG10	AWG8	AWG7	AWG7	AWG6	AWG5
10A	AWG16	AWG14	AWG11	AWG9	AWG8	AWG7	AWG6	AWG6	AWG5

Notes

- ※ The unused light should be sealed with the packaging bag to avoid prolonged exposure.
- ※ Please use DC24V isolated constant voltage power supply with ripple voltage less than 5%. Using other types of power supply may damage the light or cause other safety risks.
- ※ In practical application, 20% allowance should be reserved for power supply to ensure the stability of power supply.
- ※ It is recommended that professionals connect the power supply. Do not connect the power supply with live power to avoid electric shock.
- ※ Please confirm whether the voltage of the power supply is consistent with the voltage of the light; Pay attention to the positive and negative poles of the power cord, do not connect wrong, so as not to cause product damage;
- ※ When multiple power supplies are used, ensure that the positive poles of the power supply are not connected in parallel. Otherwise, the power supply system may be unstable or damaged after long-term operation.
- ※ If the actual application length exceeds the specified length, it will lead to overload, heating and uneven brightness of the light.
- ※ During installation, please do not scratch, twist, or bend the light irregularly. Otherwise, the light may be damaged beyond repair.
- ※ To ensure the life and reliability of the light, please do not over bend the light, which will damage the product itself.
- ※ To protect your eyes, please avoid staring at the glowing surface of the light for a long time.
- ※ Non-professionals are forbidden to install, disassemble and maintain the product.
- ※ Do not use any acid or alkaline adhesive to fix the light (including but not limited to glass glue, etc.)
- ※ IP67 products are not suitable for long-term immersion in water; IP68 products are only customized by the factory. After cutting and processing by users themselves, there is a risk that IP68 protection level cannot be reached
- ※ Because of the difference in structure, even if the same color temperature value, different sizes of light will look slightly different colors. Please confirm it before use.

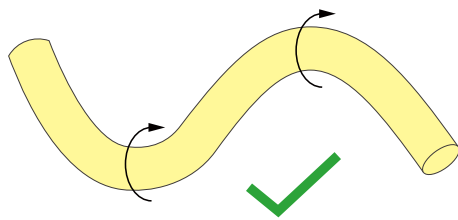

Min Bending diameter $\geq 200\text{mm}$

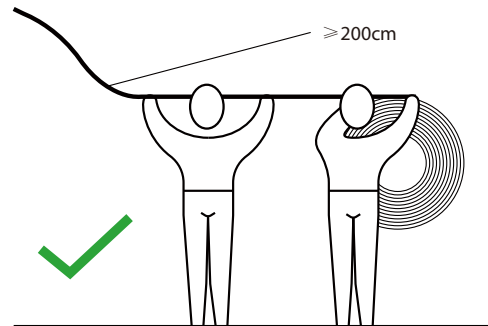

If the length of the light is more than 2 meters, two persons must work together to install it.

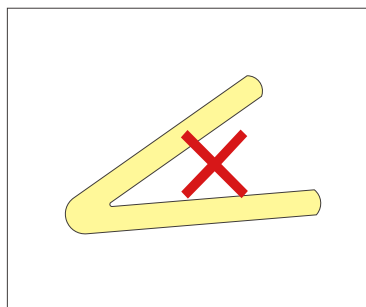

Small Angle bending is prohibited

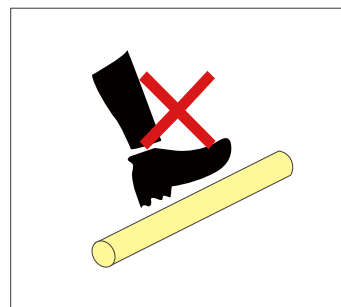

Prohibit trample

Tests showed that methanol and benzenes will have yellowing effects on silicone.

In the newly decorated interior environment, epoxy floor paint, wall paint, wallpaper adhesive, various decoration materials or new furniture, they are likely to release of methanol and benzenes.

It is recommended to remove methanol and benzenes first, or ventilate for a period of time in the newly decorated interior environment before install the silicone neon light, to avoid affecting the silicone body.