WS2812B-V5/W

Intelligent control LED integrated light source

Features and Benefits

- The control circuit and the LED share the only power source.
- Control circuit and RGB chip are integrated in a package of 5050 components, to form a complete addressable pixel.
- Built-in signal reshaping circuit, after wave reshaping to the next driver, ensure wave-form distortion not accumulate.
- Built-in electric reset circuit and power lost reset circuit.
- Each pixel of the three primary color can achieve 256 brightness display, completed 16777216 color full color display, and scan frequency is of 2KHz.
- Cascading port transmission signal by single line.
- Any two point the distance not more than 5m transmission signal without any increase circuit.
- When the refresh rate is 30fps, cascade number are not less than 1024 pixels.
- Send data at speeds of 800Kbps.
- The color of the light is highly consistent, cost-effective.
- **Reverse power supply will not damage.**
- **The periphery does not need any electronic components including capacitors.**

Applications

- Consumer electronics.
- Full-color module, LED full-color soft/hard light bar, LED decorative lighting.
- various electronic products, electrical equipment marquee.

General description

WS2812B-V5 is a intelligent control LED light source that the control circuit and RGB chip are integrated in a package of 5050 components. It internal include intelligent digital port data latch and signal reshaping amplification drive circuit. Also include a precision internal oscillator and a voltage programmable constant current control part, effectively ensuring the pixel point light color height consistent.

The data transfer protocol use single NZR communication mode. After the pixel power-on reset, the DIN port receive data from controller, the first pixel collect initial 24bit data then sent to the internal data latch, the other data which reshaping by the internal signal reshaping amplification circuit sent to the next cascade pixel through the DO port. After transmission for each pixel, the signal to reduce 24bit. pixel adopt auto reshaping transmit technology, making the pixel cascade number is not limited the signal transmission, only depend on the speed of signal transmission.

RESET time > **280μs**, it won't cause wrong reset while interruption, it supports the lower frequency and inexpensive MCU.

Refresh Frequency updates to **2KHz**, Low Frame Frequency and No Flicker appear in HD Video Camera, it improve excellent display effect.

LED with low driving voltage, environmental protection and energy saving, high brightness, scattering angle is large, good consistency, low power, long life and other advantages. The control chip integrated in LED above becoming more simple circuit, small volume, convenient installation.

WS2812B-V5/W

Intelligent control LED integrated light source

Mechanical Dimensions(Unit:mm)

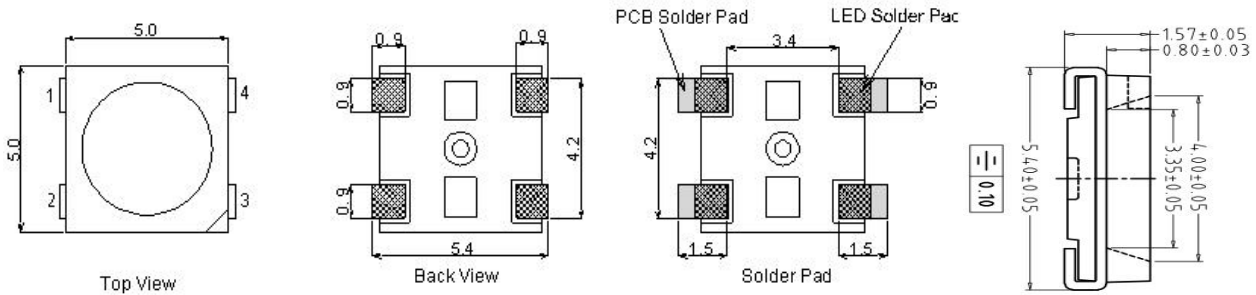

Remarks: Dimension of 5.0*5.4*1.57mm, default Tolerance of 0.05mm.

PIN Configuration

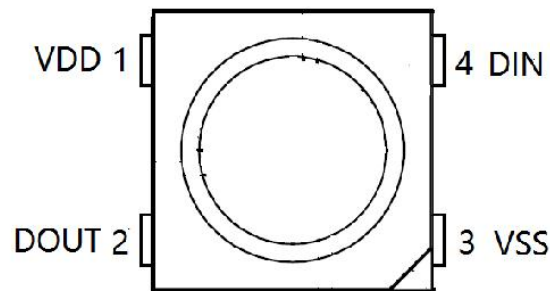

PIN Function

NO.	Symbol	PIN	Function description
1	VDD	POWER SUPPLY	Power supply
2	DOUT	DATA OUT	Control data signal output
3	VSS	GROUND	Ground,data & power grounding
4	DIN	DATA IN	Control data signal input

Absolute Maximum Ratings

Parameter	Symbol	Ratings	Unit
Power supply voltage	V_{DD}	+3.7~+5.3	V
Logical Input Voltage	V_I	-0.3V~ $V_{DD}+0.7$	V
Operation temperature	T_{opt}	-40~+65	°C
Storage temperature	T_{stg}	-40~+85	°C

WS2812B-V5/W

Intelligent control LED integrated light source

Electrical Characteristics (T_A=25°C, V_{DD}=5V, V_{SS}=0V, unless otherwise specified)

Parameter	Symbol	Min	Tpy	Max	Unit	Conditions
Input current	I _I	—	—	±1	μA	V _I =V _{DD} /V _{SS}
High Voltage Input	V _{IH}	0.63VDD	—	VDD+0.7V	V	D _{IN} , SET
Low Voltage Input	V _{IL}	-0.3V	—	0.7V	V	D _{IN} , SET

Switching Characteristics (T_A=25°C, V_{DD}=5V, V_{SS}=0V, unless otherwise specified)

Parameter	Symbol	Min	Tpy	Max	Unit	Condition
Transmission delay time	t _{PLZ}	—	—	300	ns	CL=15pF, DIN→DOUT, RL=10KΩ
Fall time	t _{THZ}	—	—	120	μs	CL=300pF, OUTF/OUTG/OUTB
Input capacity	C _I	—	—	15	pF	—

LED Characteristics (T_A=25°C, V_{DD}=5V, V_{SS}=0V)

Parameter	Symbol	Color	Quiescent Current(center value): 0.6mA				Condition (Working current)
			Mini	Tpy	Max	Unit	
Brightness	IV	Red	300	310	500	mcd	12mA
		Green	600	780	1000		
		Blue	200	215	300		
Wavelength	λ _d	Red	620	621	630	nm	12mA
		Green	515	520	525		
		Blue	465	471	475		

Data Transfer Time

T0H	0 code, high voltage time	220ns~380ns
T1H	1 code, high voltage time	580ns~1μs
T0L	0 code, low voltage time	580ns~1μs
T1L	1 code, low voltage time	580ns~1μs
RES	Frame unit, low voltage time	>280μs

WS2812B-V5/W

Intelligent control LED integrated light source

Sequence Chart

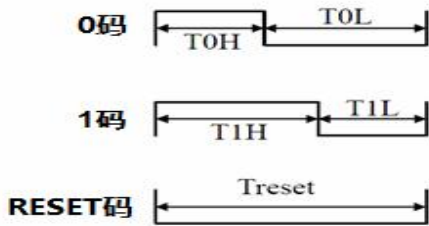

Cascade Method

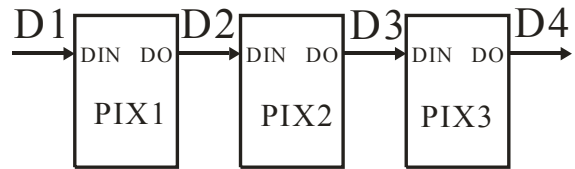

Data Transmission Method

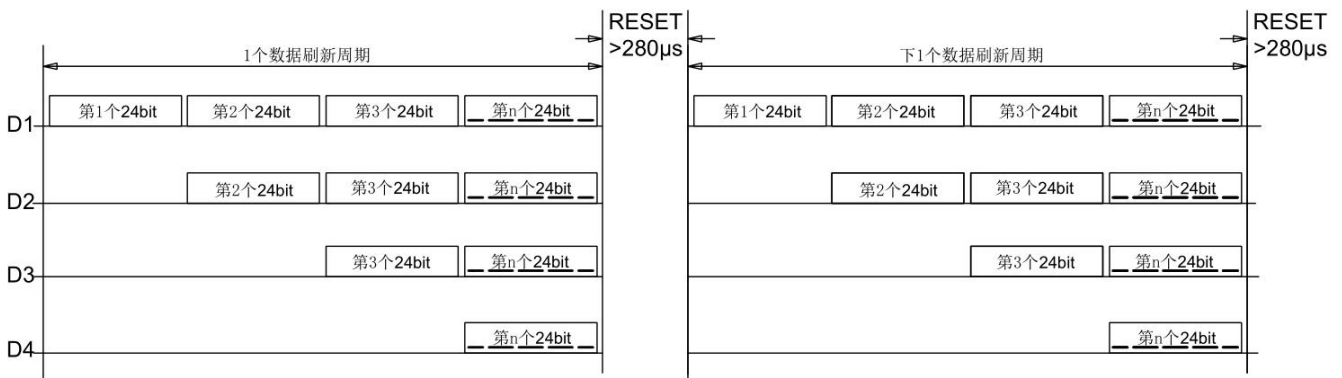

Note: The data of D1 is sent by MCU, and D2, D3, D4 through pixel internal reshaping amplification to transmit.

Composition of 24bit Data

G7	G6	G5	G4	G3	G2	G1	G0	R7	R6	R5	R4	R3	R2	R1	R0	B7	B6	B5	B4	B3	B2	B1	B0
----	----	----	----	----	----	----	----	----	----	----	----	----	----	----	----	----	----	----	----	----	----	----	----

Note: Data transmit in order of GRB, high bit data at first.

Typical Application Circuit

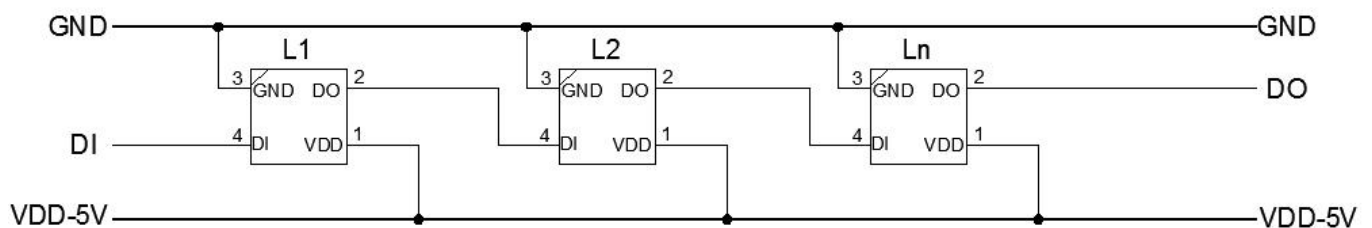

WS2812B-V5/W

Intelligent control LED integrated light source

Packing Standard

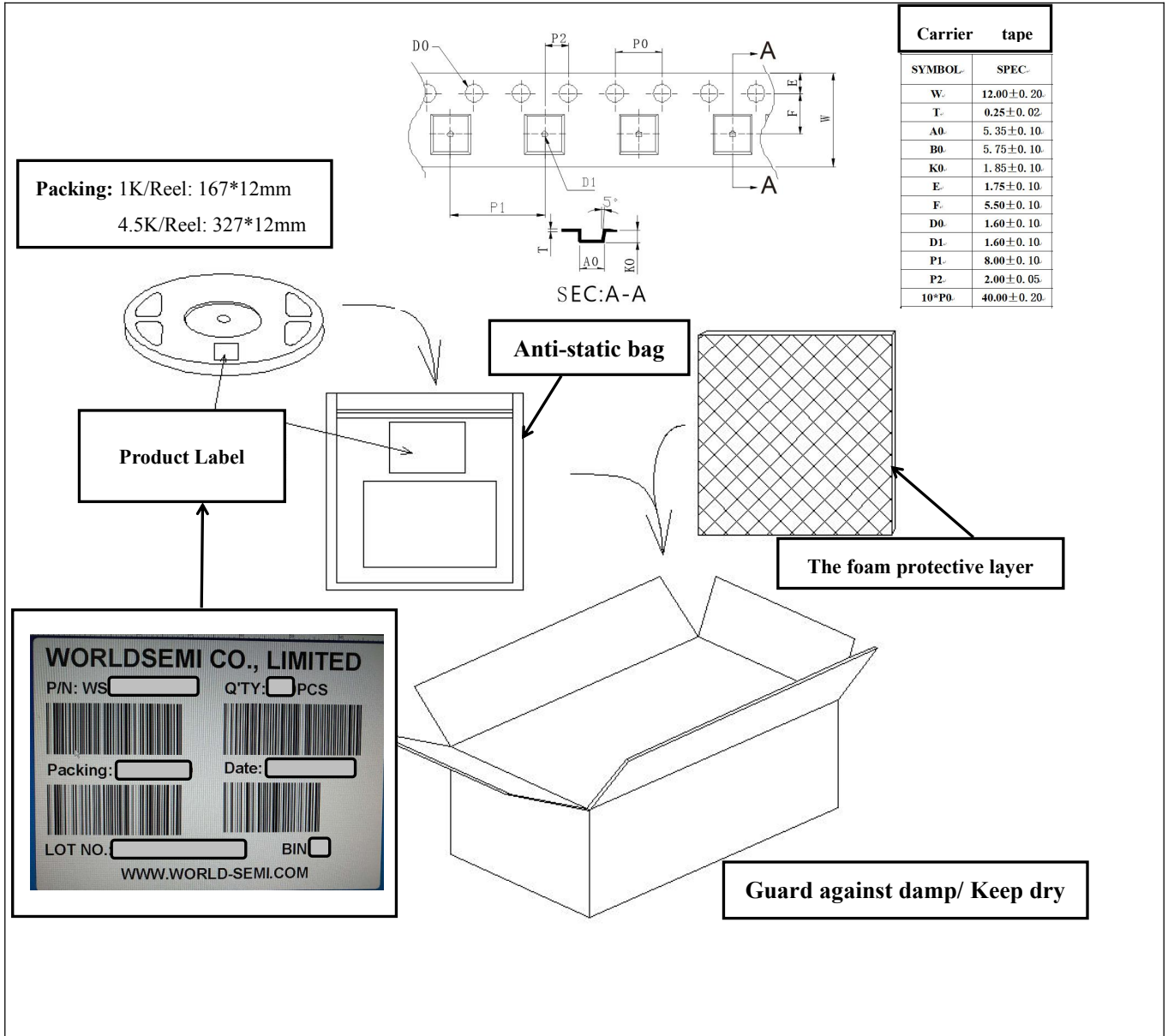

Top SMD LED Using Instructions

1. Summary

To make the best use of WORLDSEMI's LED, please refer to the below precautions, they are of same usage method as other electronic components.

2. Cautions

2.1. Dust & Cleaning

The surface of the LED is encapsulated with modified epoxy resin because it plays a very good role in protecting the optical performance and aging resistance. The modified epoxy resin is easy to stick with dust and must be kept clean. When there's a certain amount of dust on the surface of the LED, it won't affect brightness, but dust proof should be taken care of. Promoting the use of unsealed package in preference to others and the assembled LEDs should be placed in a clean container.

Avoid using the organic solvents to clean the dust on the LED surface and it's necessary to confirm whether the cleaning fluid will dissolve the LED.

Do not clean the LEDs by the ultrasonic. Some parameters affecting the LED performance must be evaluated if have no alternative but to the ultrasonic cleaning method, such as ultrasonic power, baking time and assembly conditions, etc.

2.2. Moisture-proof packaging

TOP SMD LEDs are moisture sensitive components. LEDs are packaged in aluminum foil bag to prevent the from absorbing moisture during transport and storage. A desiccant is placed in the bags to absorb moisture. If the LED absorbs moisture, then it evaporates and expands when in reflow process, which may break the colloid from the bracket and damage the optical performance of LED. For this reason, moisture-proof packaging is to prevent the from absorbing moisture during transport and storage. The moisture resistance rating of WORLDSEMI's LED is: **LEVEL 5a.**

Tabel I - IPC/JEDEC J-STD-020 Moisture/Reflow Sensitivity Classification

MSL Level	Workshop Life	
	Time	Conditions
LEVEL1	Unlimited	≤30°C/85%RH
LEVEL2	1 Year	≤30°C/60%RH
LEVEL2a	4 Weeks	≤30°C/60%RH
LEVEL3	168 Hours	≤30°C/60%RH
LEVEL4	72 Hours	≤30°C 160%RH
LEVEL5	48 Hours	≤30°C/60%RH
LEVEL5a	24 Hours	≤30°C/60%RH
LEVEL6	Take-out and Use immediately	≤30°C/60%RH

2.3 SMT Requirement:

2.3.1 It is recommended to unpack the LED before SMT and put the whole roll into the oven for dehumidification and drying (baking at 70 ~ 75 °C for ≥ 24h);

WS2812B-V5/W

Intelligent control LED integrated light source

2.3.2 The product is taken out of the oven to the completion of high-temperature soldering (including multiple high-temperature operations/operations such as reflow soldering, tin immersion, wave soldering, and heating maintenance), and the time period is controlled within 24 hours (under the conditions of $T < 30^{\circ}\text{C}$, $\text{RH} < 60\%$) ;

2.3.3 SMT shall be completed as soon as possible for LED pastes on PCBA after printing solder paste, and it is recommended not to exceed 1H;

2.3.4 Bulk LEDs such as production surplus, machine throwing materials, and maintenance materials cannot be used directly if they are exposed to the air for a long time. It is recommended to dehumidify and dry before use. Whole roll baking: $70 \sim 75^{\circ}\text{C} * \cong 24\text{H}$ or bulk material baking: $120^{\circ}\text{C} * 4\text{H}$.

3. SMT Reflow

Refer to the parameters listed below, the experimental results prove that the TOP SMD LED meets the JEDEC J-STD-020C standards. As a general guideline, it is recommended to follow the SMT reflow temperature curve recommended by the solder paste manufacturer.

Temperature curve description	Range
30 °C ~ 150 °C preheating slope	1~4 °C/s
30 °C ~ 150 °C preheating time	60~120 s
Constant temperature slope of 150 °C ~ 200 °C	0~3 °C/s
Constant temperature time of 150 °C ~ 200 °C	60~120 s
LIQUID REGION temperature	217°C
Peak Temperature (Tp)	245°C
Reflow slope	0~3 °C/s
Reflow time	45-90 s
cooling rate	-4~0 °C/s
Room Temperature to Peak Holding Time	<6 min

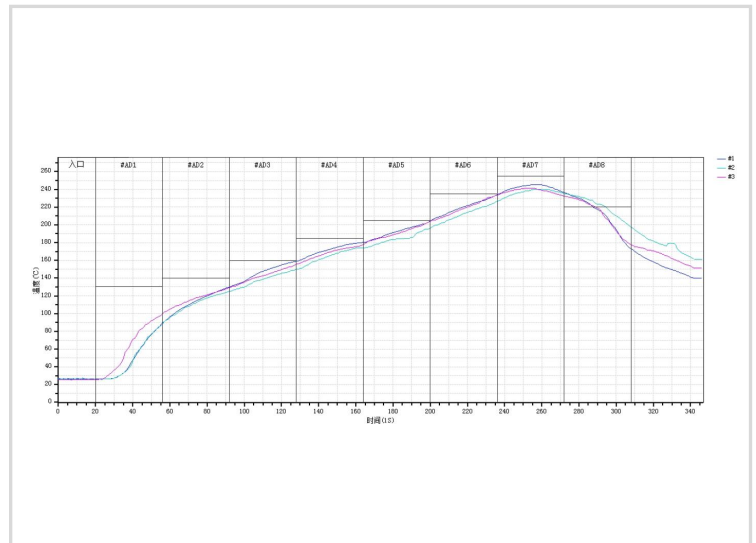

Remarks: All temperatures referred are measured on the surface of the package body.

4. Assembly Precautions

1. Clip the LED from its side.	2. Neither directly touch the gel surface with the hand or sharp instrument, it may damage its internal circuit.	3. Not to be double stacked, it may damage its internal circuit.	4. Can not be stored in or applied in the acidic sites of $\text{PH} < 7$.
--------------------------------	--	--	---

WS2812B-V5/W

Intelligent control LED integrated light source

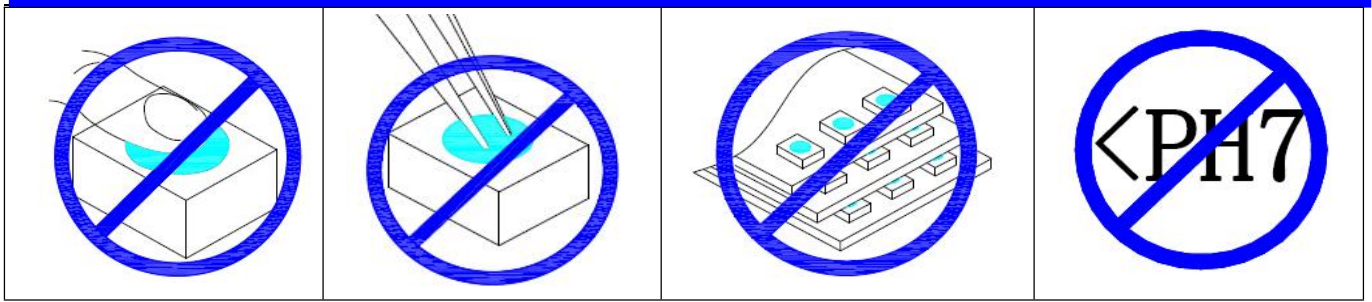

Modify Record

Version №	Status Bar	Modify Content Summary	Date	Reviser	Approved
V1.0	N	New	20170523	Shen JinGuo	Yin HuaPing
V1.1	M	Absolute Maximum Ratings	20171009	Shen JinGuo	Yin HuaPing
V1.2	M	Absolute Maximum Ratings, timing	20180207	Shen JinGuo	Yin HuaPing
V2.0	M	Electrical parameters	20180412	Shen JinGuo	Yin HuaPing
V3.0	M	Notes section	20180719	Shen JinGuo	Yin HuaPing
V4.0	M	Logic input voltage; Brightness value calibration	20180822	Shen JinGuo	Yin HuaPing
V5.0	M	IC upgrade, reverse power supply will not be damaged; no need for any electronic components including capacitors	20190323	Shen JinGuo	Yin HuaPing
V5.1	M	Product assembly process precautions; SMT instructions	20200722	Shen JinGuo	Yin HuaPing
V6.0	M	The colloid is changed to mist, part number is changed to WS2812B-V5/W	2021/12/2	Yu XingHui	Yin HuaPing
V6.1	A	Add items of operation temperature and storage temperature	2022/9/8	Yu XingHui	Yin HuaPing

Remarks: Initial version: V1.0; Version number plus "0.1" after each revision;

Status bar: N--New, A--Add, M--Modify, D--Delete.